



HOBOT-298

**Window Cleaning Robot - Ultrasonic Spray
User's Manual**



Copyright

Copyright © 2018 by HOBOT® Technology Inc. All rights reserved. No part of this publication may be reproduced, transmitted, transcribed, stored in a retrieval system or translated into any language or computer language, in any form or by any means, electronic, mechanical, magnetic, optical, chemical, manual or otherwise, without the prior written permission of this company.

Trademarks

All other logos, products, or company names mentioned in this manual may be the registered trademarks or copyrights of their respective companies, and are used for informational purposes only.

Technical Support

If any problems occur and this manual cannot provide the solution you need, please contact a local retailer or local authorized dealer.

Disclaimer

HOBOT Technology Inc. makes no claims or warranties, either expressed or implied, with respect to the contents hereof and specifically disclaims any warranties, tradability or suitability for any particular purpose. Furthermore, HOBOT Technology Inc. reserves the right to revise this publication and to make changes from time to time in the contents hereof without obligation of this company to provide notification of such revisions or changes.

The user should follow the instructions provided in this user manual, but is ultimately responsible for assessing placement and safety when using this glass cleaning tool.

Important Safety Precautions

Read all instructions before operating this device.

WARNING

1. Fasten the safety rope and tie to an indoor fixture before operating the device.
2. Check if the safety rope is broken or the knot is loose before operating the device.
3. A power cord must be used for the HOBOT to function properly.
4. For windows with no balcony, a warning area must be established on the ground below to prevent people from coming near it.
5. The battery must be fully charged (green light ON) before using.
6. Do not use on rainy or humid days.
7. Turn power on before putting device onto window.
8. When placing the appliance onto window, make sure it sticks to the surface before removing the supporting hand.
9. Remove the device before turning the power off.
10. Make sure to put the cleaning cloth onto the device correctly to avoid air leakage.
11. Do not spray or pour water onto the device.
12. Prohibit children from using this device.
13. Remove any obstructions on window. Do not use on cracked window. Reflective or coated window may be scratched during operation by dirt on the window.
14. Keep hair, loose clothing, fingers, and all body parts away from the openings and moving parts.
15. Do not use in areas containing flammable or combustible liquids or gases.
16. Only fill the water tank with water or HOBOT window detergent, other detergents are not allowed.
17. Empty the water tank before putting the device away.

Product Description

HOBOT-298 has AI Technology embedded that calculates paths and auto-detects window edges; you can clean your windows as easy as in one touch. HOBOT-298 also brings revolutionary bio-mimicry technology into play! The new patented invention carries a detachable water tank along with an ultrasonic water spray nozzle which nebulizes water to 15um mists then sprays it evenly on glass like the effect of human exhales on glass surface. HOBOT-298 is very water-conservation and eco-friendly, it can clean one square meter area with just one milliliter water or detergent. Additionally, the easily-replaceable microfiber cloth not only attracts dirt into fibers but also absorbs water to offer smear-free finish.

Specifications

Product size	240 mm x 240 mm x 100 mm (LWH) (9.5 in x 9.5 in x 3.9 in)
Product weight	1.28 Kg (2.82 lbs)
Gift box size	340 mm x 255 mm x 125 mm (LWH) (13.4 in x 10.0 in x 4.9 in)
Total gift box weight	2.54 Kg (5.60 lbs)

Input Voltage	100~240VAC, 50Hz~60Hz
Adapter output	Minimum 24V/3.0A
Power consumption	72 W
AC power cord length	1.0 m (3.3 feet)
DC extension cord length	4.0 m (13.1 feet)
Safety rope length	4.5 m (14.8 feet), Strength:150 Kgf
Replaceable water tank	50 ml
Nozzle type	Ultrasonic, 108 Khz (Kilo Hertz)
Water particle size	15 µm (Micrometer)
Glass detergent	250 ml
Battery	Li-Ion, 4x3.7V
Battery working time	20 minutes
Battery life	2 years
Cleaning speed	2.4 min/m ² (14.5 sec/ feet ²)
Noise	64 dB
Maximum cleaning area	Height: 6.0 m (19 feet) Width: 5.0 m (16 feet)

Product and Accessories

- Device x 1
- Adapter x 1
- AC power cord x 1
- DC extension cord x 1
- Remote control x 1
- Window detergent x 1
- Microfiber polishing cloth x 3
- Safety rope x 1
- User manual x 1

Overview

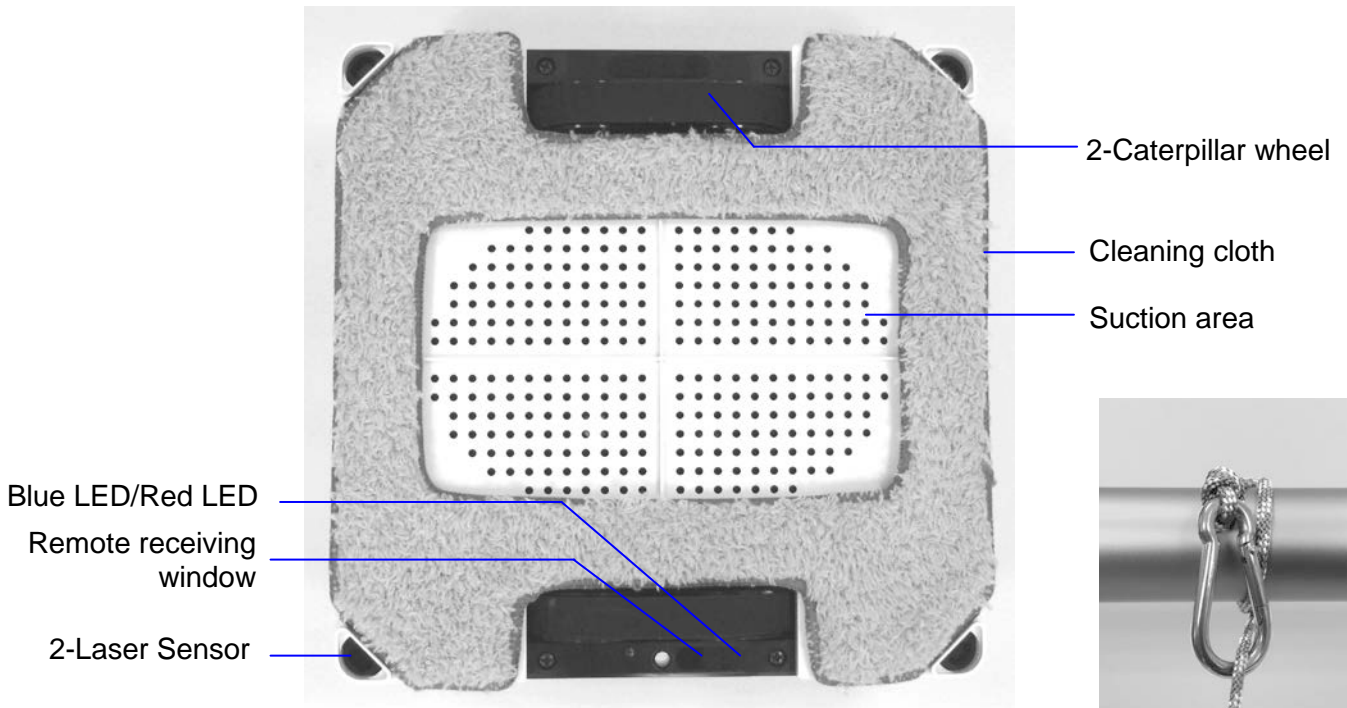
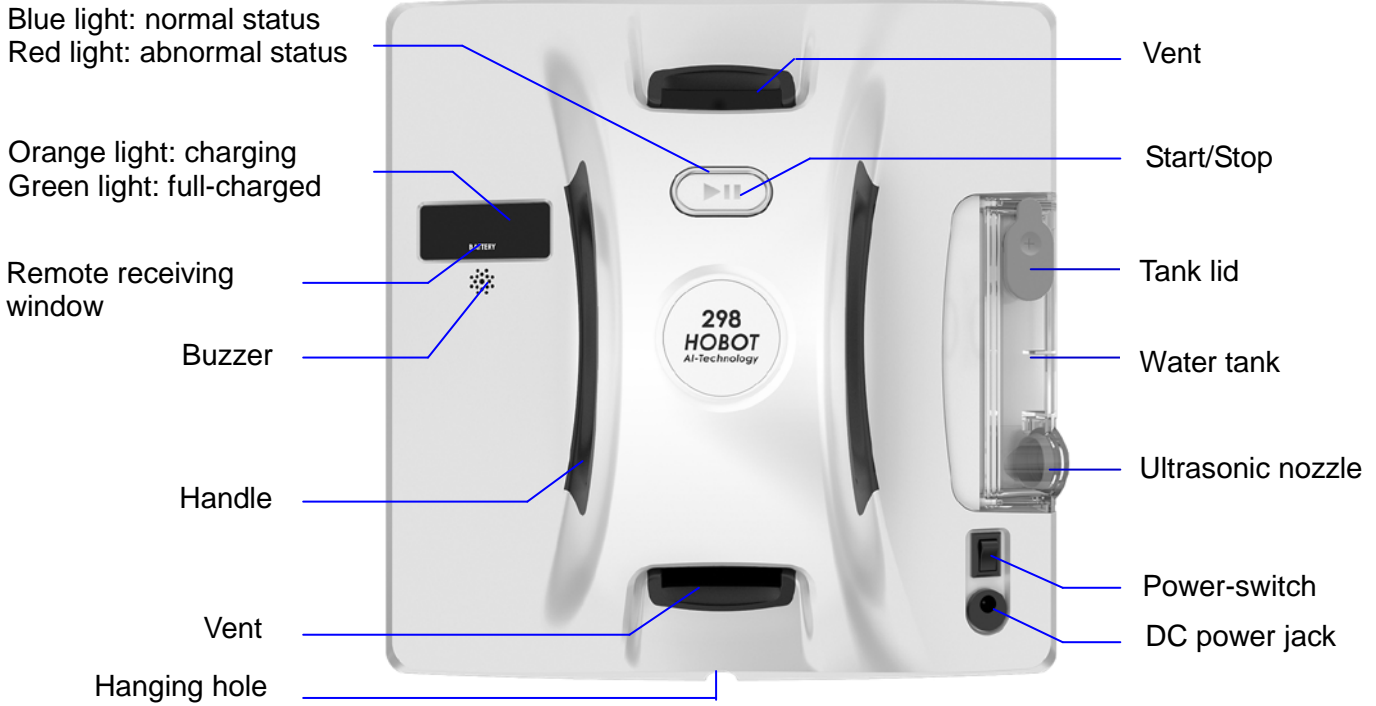

Safety rope & buckle

Get Started

Step 1. Preparing

- (1) Do not use the device on rainy or humid days.
- (2) For windows with no balcony, a warning area must be established on the ground below to prevent people from coming near it.
- (3) Check to see if the safety rope is broken or if the knot is loose.

(4) Fasten the safety rope and tie to an indoor fixture before operating if clean outside of higher floor window.

Step 2. Connect the adaptor and DC extension cord to HOBOT correctly.

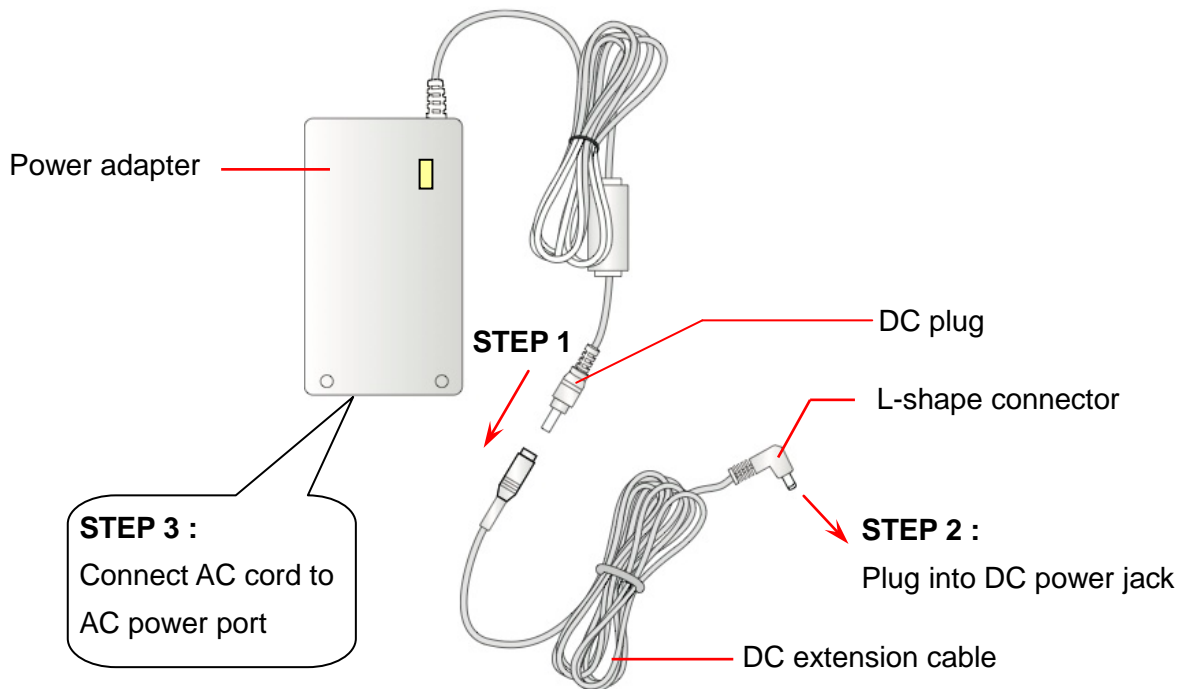

Step 3. Make sure the battery is fully charged (green light ON) before using:

(1) Plug it into a power source. Orange light ON means charging.

(2) Green light ON means the battery is fully charged.

Step 4. Make sure to put the cleaning cloth onto the device correctly to avoid air leakage.

(1) HOBOT has 2-laser sensors for detecting glass edge. These laser sensors cannot be covered by cleaning cloth like as shown.

(2) Put cleaning cloth onto device flatly and do not let cloth cover the caterpillar wheel and laser sensors.

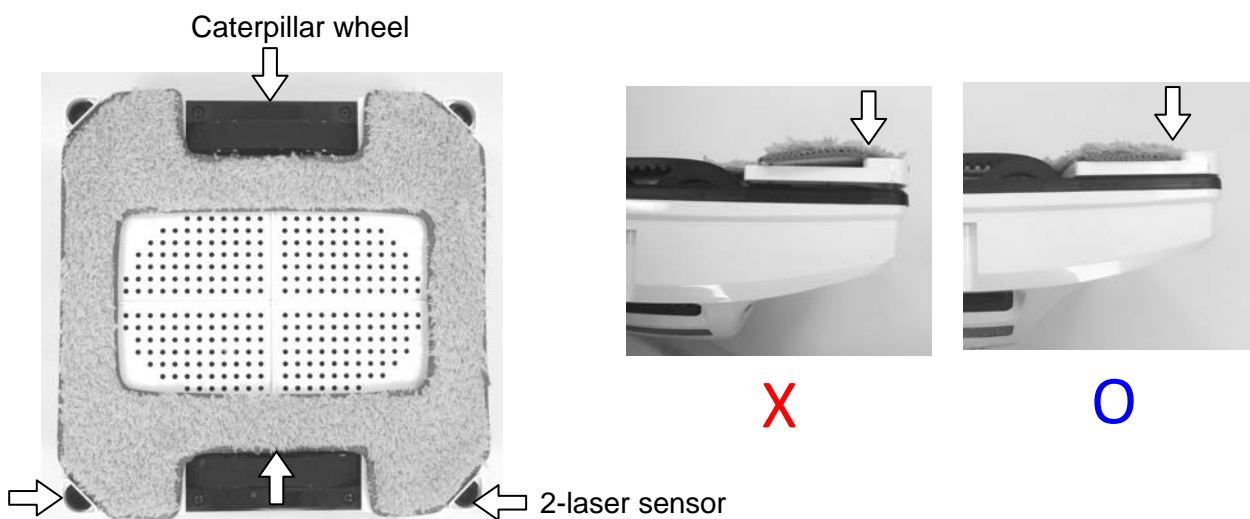

Step 5. Fill the water tank with water or HOBOT window detergent and tighten the tank lid fully after filling.

Step 6. Put the device onto window.

(1) Turn power switch on make sure fan is running.

(2) Put device onto window and keep 10cm away from the window frame.

(3) Check if device is sticking to the window before releasing it.

Step 7. Auto mode or manual mode operation.

(1) Operate HOBOT by remote control. There are 3 kinds auto mode (▲8) (◀8) (8▶) that could automatically clean whole window.

(2) Press (OK) or (STOP) to stop device running.

(3) Press (▲) (▼) (▶) (◀) to manually control device moving.

Step 8. Finish and remove the device from window.

(1) While device is running, hold the safety rope with one hand and take device down from window with the other hand.

(2) Remove the device to a safe area, then turn it off.

Maintenance

● Clean the caterpillar belt

When the device easily slips on the surface of window, it is because belts are stained with accumulation of dust after using. Please follow 3 steps below.

Step 1: Turn the device upside down.

Step 2: Turn power switch on, the device's caterpillar belts continually rotate for 3 minutes.

Step 3: Customers use cloth clean caterpillar belts and keep cloth in the middle of belts to avoid cloth being jammed in the belts. If cloth is jammed, users can turn power switch off and draw it out.

Frequency: Before each use



- Clean two laser sensors

Use a clean and dry soft cloth to clean two sensors.

Frequency: Before each use

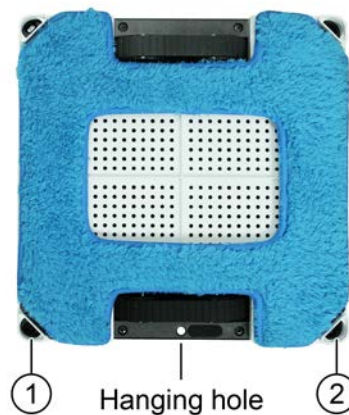

- Replace the water tank

When ultrasonic nozzle is jammed and cannot spray water.

Step 1. Use a flathead screwdriver to remove the screw.

Step 2. Remove a connector from an old water tank and then draw the tank out.

Step 3. Plug the connector of a new water tank and insert the tank into the device, then screw it.

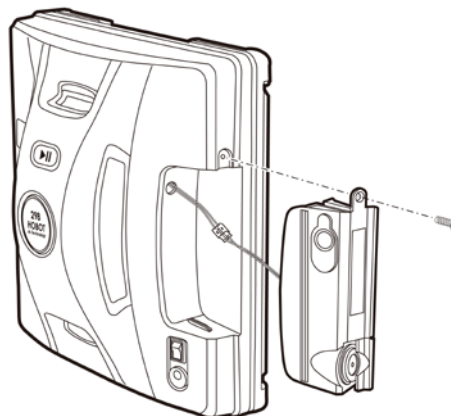

UPS (Uninterrupted Power System) Function

- (1) The UPS function will be enabled automatically when no electric power is supplied. The backup time of this UPS is 20 minutes.
- (2) If no electric power is supplied, the device will stop automatically, sound an alert, and flash a red light. The user should take the device down from the glass as soon as possible.
- (3) The safety rope can be used to pull the device back. Gently pull the safety rope at an angle close to the glass to prevent it from falling off.









Cleaning Tips

- Dusty windows must be cleaned with a dry-cleaning cloth or with the device without turning on the spraying function.

- If there is water or detergent on the cloth or window, the water or detergent will mix together with the dust or dirt to become mud. Thus, dusty windows must be cleaned with dry- cleaning cloth as the first step of cleaning wondows, no water or detergent is needed, exterior windows especially.
- **Use HOBOT on sunny days or days with low humidity for best results.**
- **The surface of window with water molecules becomes slippery and has white streaks left on the window so it is not suggested using the device to clean exterior windows on rainy or high humidity days.**

Remote Control

The device can be remote controlled from the front and back sides.
To replace the battery, just pull down the battery cover.

Setup Direction	Horizontal Setup	Vertical Setup
		
	Zigzag, then N-way auto-clean whole window	N-way auto-clean whole window
	move LEFT then Zigzag auto-clean the rest window	move UP then N-way auto-clean the rest window
	move RIGHT then Zigzag auto-clean the rest window	move DOWN then in N-way auto-clean the rest window
	Manually move UP, DOWN, RIGHT, LEFT	
	Stop	
	Clean twice	
	Spray ON/OFF	

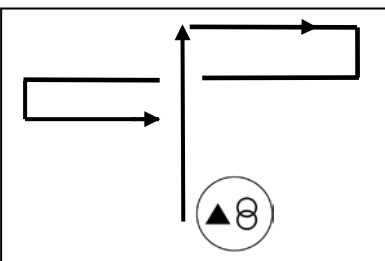

Auto up then down

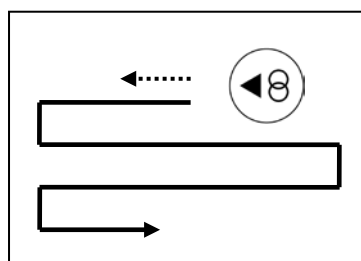

Auto left then down

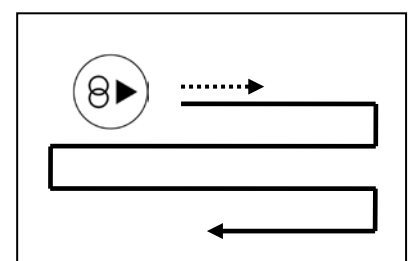

Auto right then down

Set Up The Device With HOBOT App.

Step 1. Scan QR code or search “HOBOT” on the App Store or Google Play to download HOBOT App on your smart phone or tablet.

Step2. Turn on Bluetooth and click HOBOT App.

Step3. Turn on the device and wait for “Connected” shown on HOBOT App.



Make sure both HOBOT App and the device are on, so you can use your iOS or Android smart device to operate the device.

LED Indication

Situation	LED indication/Sound
1. Spraying function is on	Blue LED is ON
2. Spraying function is off	White LED is ON
3. Battery charging	Orange LED is ON
4. Battery charged full	Green LED is ON
5. No electrical power	Blue LED is ON Red LED flashing Sound: repeat beep
6. Hardware error	Red-LED flashing Blue-LED flashing with “error number” Sound: beep once 60 seconds
7. Vacuum pressure too low	Blue LED is ON Red-LED flashes once Sound: single beep
8. Air leakage while operating	Blue LED is ON Red-LED flashes once Sound: single beep

Frequently Asked Questions (FAQ)

Q1: When the power switch is turned on, the fan does not rotate, and no any beep sounds.

Case	LED indication / Sound	Situation and Solution
1. Battery voltage is too low	Blue: flash Red: off Orange: on Sound: no beep	It means battery charge is too low. Wait for battery to fully charge (green light is on). If machine still can't be used after charging for 8 hours, the battery should be changed.
2. Hardware failure	Blue: flash Red: flash Sound: beep	Machine hardware failure. Please contact a local retailer or local authorized dealer for repairs.

Q2: When the power switch is turned on, the fan is rotating, Blue-LED is lighting, Red-LED is flashing, with repeat beep sounds.

Ans: No electrical power supplied. Please connect and check power cord, adapter, and the device.

Q3: When the power switch is turned on, HOBOT can't start up by remote control.

Case	LED indication / Sound	Situation and Solution
1. Pressure not enough	Blue: on Red: flash one time Sound: single beep	The vacuum pressure is not enough. User could re-attach cleaning cloth onto device again, or change a new cleaning cloth.
2. Remote control failure	Blue: on Red: off Sound: no beep when press remote key	Remote control failure. Please contact a local retailer or local authorized dealer for repairs.

Q4: The HOBOT slips and cannot detect the upper frame of window in "Auto Up then Down" (▲⊗) mode.

Ans: (1) Press (OK) or (STOP) to stop, switch to (▼) manual mode to lower the half of the device and then switch to "Auto Up then Down" (▲⊗) mode again.

or, (2) Press (OK) or (STOP) to stop, switch to (▼) manual mode to lower the half of the device and then switch to (⊗▶) or (◀⊗) auto mode.

Q5: HOBOT cannot finish cleaning the whole window and stops in the middle area.

Ans: Press  or  auto mode to continue cleaning.

Q6: HOBOT slips and cannot reach the top of window.

Ans: (1) The cleaning cloth already got heavy dirt or too wet. It shall change cleaning cloth.

(2) The caterpillar belt might be too wet or got heavy dust. It shall clean caterpillar belt.

Q7: HOBOT does not move smoothly, or it moves irregularly.

Ans: (1) Cleaning cloth is too dirty. Please change a clean-cleaning cloth and clean again.

(2) Window surface has different friction factor areas due to glass stickers, window film, and so on. Please limit use the HOBOT to certain areas of the window.

Q8: What to do if HOBOT stops due to a power outage?

Ans: (1) User can pull HOBOT back with the safety rope. Gently pull the safety rope at an angle close to the glass to prevent it from falling off the window.

(2) Switch the power switch to “off”.

(3) Check whether there is a poor connection or broken cord.

Q9: What to do if HOBOT unexpectedly stops and the red light is flashing, with no alarm sounding?

Ans:(1) User can move HOBOT to safe area by remote control, or pull HOBOT back with the safety rope. Gently pull the safety rope at an angle close to the glass to prevent it from falling off the window.

(2) Remove obstacles on the window surface.

(3) Check whether there is air leakage caused by a gap or uneven window frame.

Q10: The device cannot spray water.

Ans:(1) Check if you have turned on the spraying function.

(2) Clean the surface of the ultrasonic nozzle with a soft, dry and clean cloth.

(3) Change the water tank if Answer (1) and (2) are inapplicable.

Safety Information About Adapter/Battery

- Use only the power adapter supplied with this device. Use of other types of power adapters will result in malfunction and/or danger.
- Please use a proper electrical outlet and make sure no heavy objects are placed on the power adapter or the power cord.
- Allow adequate ventilation around the adapter when using it to operate the device. Do not cover the power adapter with objects that will reduce ventilation and cooling.
- Do not use the adapter in a humid environment. Never handle the adapter with wet hands.
- Connect the adapter to a proper power source. The voltage requirements are listed on the adapter.
- Do not use a broken adapter, power cord, or plug.
- Do not attempt to service the adapter. There are no service parts included. Replace the whole unit if it is damaged or exposed to high moisture. Consult your HOBOT dealer for help and maintenance.
- The battery used in this device may present a risk of fire or chemical burn if mistreated. Do not disassemble, short the contacts, heat above 60°C (140°F), or incinerate.
- If you have to dispose of old equipment, please take it to the local recycling center for recycling electrical and electronic parts.
- Please charge the battery every 3 months to conserve the battery life.

General Safety Information

- Retain the safety and operating instructions for future reference.
- Follow all operating and use instructions.
- Do not expose your device to rain or excess humidity, and keep it away from liquids (such as beverages, faucets, and so on).
- Avoid exposing your device to direct sunlight or sources of intense light, and keep it away from sources of heat (such as radiators, space heaters, stoves, and so on).
- Do not place the device in the vicinity of strong magnetic fields.
- Keep the device and accessories away from children.
- Product operating temperatures: 0°C~40°C (32°F~104°F).
- Product storage temperatures: -10°C~50°C (14°F~122°F).

Cleaning Cloth Laundry Instructions

- Washing under 40°C (104°F)
- Do not bleach
- Do not tumble-dry
- Do not iron
- Do not dry clean

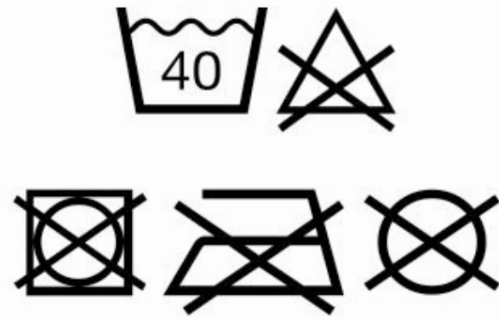

Limited Warranty

If there are defects in your HOBOT window cleaning robot due to faulty materials, poor workmanship, or malfunction within the warranty period from the date of purchase or delivery, please contact a local retailer or local authorized dealer for repairs or replacement.

Not Covered By Warranty

- Normal wear and tear (e.g. cleaning cloth, safety rope, water tank, etc).
- Reduction in battery discharge time due to battery age or use.
- Damage caused by assembly or installation that is not in accordance with the instructions included with the HOBOT.
- Damage caused by using the HOBOT window cleaning robot for anything other than normal domestic household purposes.
- Damage caused by using parts and accessories which are not specified by HOBOT.
- Damage caused by accidents, abuse, or misuse.



Hobot Technology Inc.

www.hobot.com.tw