

Safety Information

Important Safety Information

This owner's guide includes information for Regulatory Model(s): RVA-Y1, ADC - N1

SAVE THESE INSTRUCTIONS

⚠ WARNING: When using an electrical appliance, basic precautions should always be followed, including the following:

READ ALL INSTRUCTIONS

⚠ WARNING: To reduce the risk of injury or damage, read and follow the safety precautions when setting up, using and maintaining your robot.

This appliance can be used by children aged from 8 years and above and persons with reduced physical, sensory or mental capabilities or lack of experience and knowledge if they have been given supervision or instruction concerning use of the appliance in a safe way and understand the hazards involved. Children shall not play with the appliance. Cleaning and user maintenance shall not be made by children without supervision.

⚠ WARNING: Cancer and Reproductive Harm – www.P65Warnings.ca.gov/product

⚠ This is the safety alert symbol. It is used to alert you to potential physical injury hazards. Obey all safety messages that follow this symbol to avoid possible injury or death.

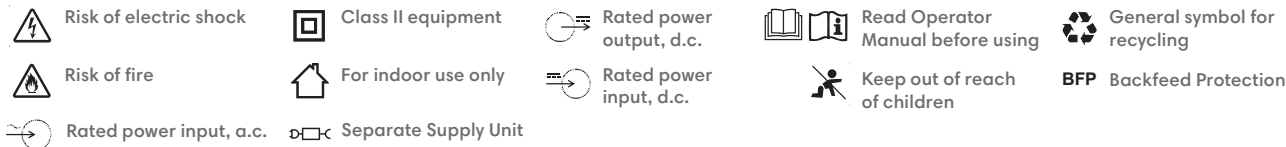

WARNING: Indicates a hazardous situation that, if not avoided, could result in death or serious injury.

CAUTION: Indicates a hazardous situation that, if not avoided, could result in minor or moderate injury.

NOTICE: Indicates a hazardous situation that, if not avoided, could result in property damage.

GENERAL



- Your robot is not a toy. Small children and pets should be supervised when your robot is operating.
- Do not sit or stand on your robot or dirt disposal.
- Do not use unauthorized chargers. Use of an unauthorized charger could cause the battery to generate heat, smoke, catch fire, or explode.
- This product comes with a region approved power supply cord and is designed to be plugged into a standard household AC power outlet only. Do not use any other power supply cord. For replacement cords, please contact Customer Care to ensure proper selection of country specific power supply cord.
- Do not open your robot or dirt disposal unless instructed to do so. There are no user serviceable parts inside. Refer servicing to qualified service personnel.
- Risk of electric shock, use indoors in dry location only.
- Do not handle your robot or dirt disposal with wet hands.
- Store and operate this product in room temperature environments only.
- If the room to be cleaned contains a balcony, a physical barrier should be used to prevent access to the balcony and ensure safe operation.

ROBOT



- Do not operate the robot in areas with exposed electrical outlets in the floor.
- If the robot passes over a power cord and drags it, there is a chance an object could be pulled off a table or shelf. Before using the robot, pick up objects like clothing, loose papers, pull cords for blinds or curtains, power cords, and any fragile objects.
- Be aware that the robot moves on its own. Take care when walking in the area that the robot is operating in to avoid stepping on it.
- Do not use the robot to pick up sharp objects, glass, or anything that is burning or smoking.

NOTICE

- This robot is intended for dry floor use only. Do not use the robot to pick up spills. Do not allow your robot or dirt disposal to become wet.
- Do not place anything on top of your robot.
- The failure to maintain cleanliness of charger contacts could result in loss of ability for the robot to charge the battery.

CHARGING STATION



- Do not use a charging station with a damaged cord or plug if the cord or plug is damaged, it must be replaced.
- Always disconnect your robot from the charging station before cleaning or maintaining it.

- Charge your robot only with Home Base model ADC - N1. The provided power supply delivers safety extra low voltage corresponding to the input marking on the robot which is required to maintain safe operation.
- To prevent the risk of your robot falling downstairs, ensure that the charging station is placed at least 4 feet (1.2 meters) away from stairs.

NOTICE

- Product may not be used with any type of power converter. Use of power converters will immediately void the warranty.
- If you live in an area prone to electrical storms, it is recommended that you use additional surge protection. Your charging station may be protected with a surge protector in the event of severe electrical storms.

BATTERY



- Do not open, crush, heat above 176°F: 80°C, or incinerate. Follow manufacturer’s instructions.
- Do not short-circuit the battery by allowing metal objects to contact battery terminals or immerse in liquid. Do not subject batteries to mechanical shock.
- Periodically inspect the battery pack for any sign of damage or leakage. Do not charge damaged or leaking battery packs, do not allow the liquid to come in contact with skin or eyes. If contact has been made, wash the affected area with copious amounts of water and seek medical advice. Place the battery in a sealed plastic bag and recycle or dispose of safely according to local environmental regulations, or return it to your local authorized iRobot Service Center for disposal.

CAUTION

- Battery usage by children should be supervised. Seek medical advice immediately if a cell or a battery has been swallowed.



NOTICE

- The battery pack must be removed from the robot before recycling or disposal.
- For best results, use only the iRobot Lithium Ion Battery that comes with the robot.
- For replacement, purchase identical iRobot battery or contact iRobot Customer Care for alternative battery options.
- Do not use non-rechargeable batteries.
- Always charge and remove the battery from your robot and accessories before long-term storage.

About your Roomba® Robot Vacuum

Top View

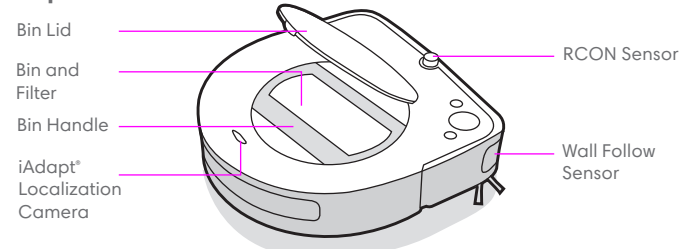

Bottom View

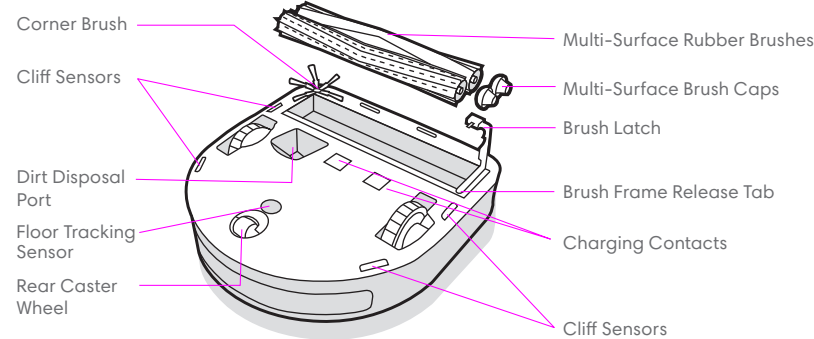

Buttons & Indicators

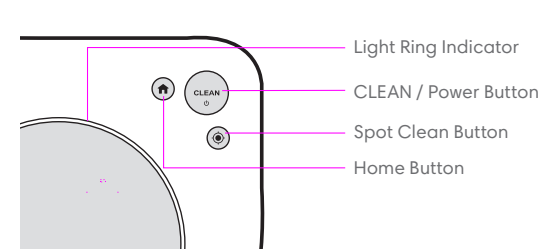

Home Base™ Charging Station

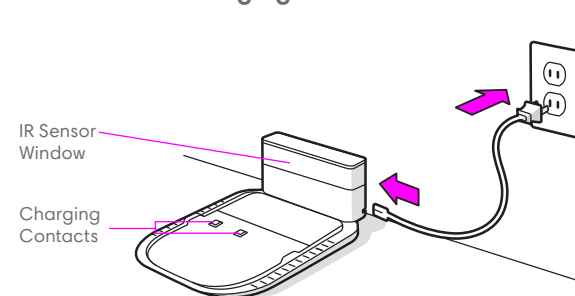

Using Your Roomba® Robot Vacuum

Positioning the Home Base™ Charging Station

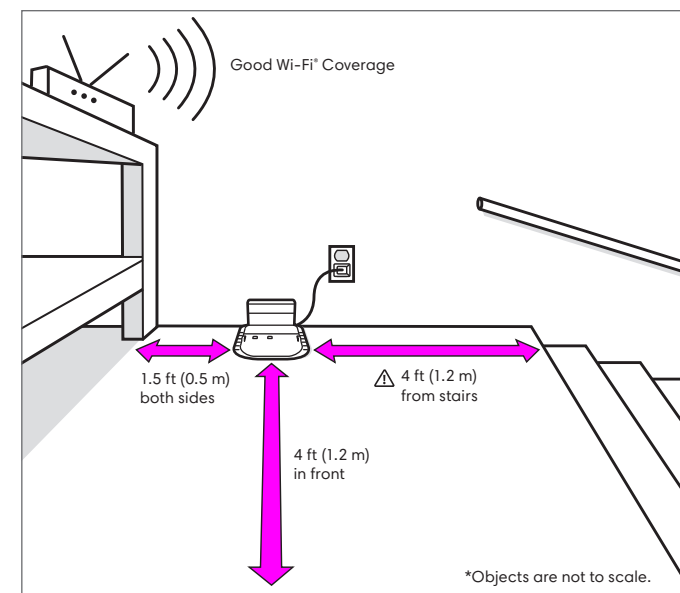

WARNING: To prevent the risk of your robot falling downstairs, ensure that the dirt disposal is placed at least 4 feet (1.2 meters) away from stairs.

Charging

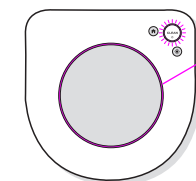

Light Ring While Charging
 Solid: fully charged
 Pulsing: charging
 Turns off after 1 minute to save power

- Place the robot on the charging station to activate the battery.
- Note:** Your robot comes with a partial charge, but we recommend that you charge the robot for 3 hours prior to starting the first cleaning job.
- If the "CLEAN" text is pulsing while charging, the robot is in the middle of a cleaning job and will automatically resume where it left off once recharged.
- The robot uses a small amount of power whenever it is on the dirt disposal. You can put the robot in a further-reduced power state when not in use. For instructions and more details on this Reduced Power Standby Mode, refer to the iRobot HOME App.
- For long-term storage, turn off the robot by removing it from the dirt disposal and holding down  for 10 seconds. Store the robot in a cool, dry place.

Cleaning

Use your robot frequently to maintain well-conditioned floors.

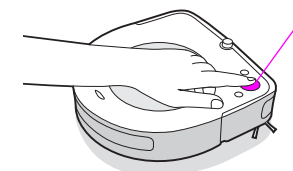

Just Press CLEAN
 Tap to Start / Pause / Resume
 Hold for 3 seconds to end a job and put the robot to sleep
 Hold 10 seconds to reboot

- Your robot will automatically explore and clean your home. It will return to the dirt disposal at the end of a cleaning job and whenever it needs to recharge.
- To send the robot back to its dirt disposal, tap 🏠. A blue light ring pattern will indicate that the robot is seeking the dirt disposal.
- When your robot detects an especially dirty area, it will engage Dirt Detect™ mode, moving in a forward/backward motion to clean the area more thoroughly. The light ring indicator will flash blue.
- Tap 🎯 to spot clean a designated area. The robot will spiral outward about 3 feet (1 meter) and then spiral inward to end where it started. The light ring indicator will show a blue spiral.

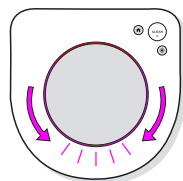

When the robot senses its bin needs to be emptied, the light ring indicator will illuminate in a red sweeping motion toward the rear.

Troubleshooting

- Your robot will tell you something is wrong by playing an audio alert and turning the light ring indicator red. Press CLEAN for details. Further support and instructional videos are available in the iRobot HOME App.
- After 90 minutes of inactivity off the dirt disposal, the robot will automatically end its cleaning job.

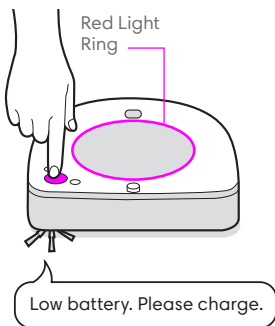

Lithium Ion Battery

For best results, only use the iRobot Lithium Ion Battery that comes with your Roomba® robot vacuum.

⚠️ WARNING: Lithium ion batteries and products that contain lithium ion batteries are subject to stringent transportation regulations. If you need to ship this product (with the battery included) for service, travel or any other reason, you MUST follow the below shipping instructions.

- Battery MUST be turned off before shipping.
- Turn off the battery by removing the robot from the dirt disposal and holding down the 🏠 for 10 seconds. All indicators will turn off.
- Package the product in its original packaging.
- Ship via ground transportation only (no air shipping).
- If you need further assistance, contact our Customer Care team.

Care and Maintenance

Robot Care and Maintenance Instructions

To keep your robot running at peak performance, perform the procedures on the following pages.

There are additional instructional videos in the iRobot HOME App. If you notice the robot picking up less debris from your floor, empty the bin, clean the filter and clean the brushes.

Part	Care Frequency	Replacement Frequency*
Bin	Wash bin as needed	N/A
Filter	Clean once a week (twice a week if you have a pet). Do not wash.	Every 2 months
Corner Brush	Clean once a month	Every 3 months
Full Bin Sensors	Clean every 2 weeks	N/A
Rear Caster Wheel	Clean every 2 weeks	Every 12 months
Multi-Surface Brushes	Clean once a month (twice a month if you have a pet)	Every 12 months
Sensors and Charging Contacts	Clean once a month	N/A

📄 Note: iRobot manufactures various replacement parts and assemblies. If you think you need a replacement part, please contact iRobot Customer Care for more information.

*Replacement frequency may vary. Parts should be replaced if visible wear appears.

Emptying the Bin

- 1 Press the bin lid release and lift the bin.

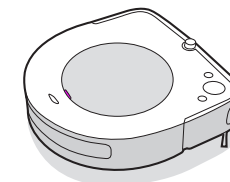

- 2 Lift the handle to remove the bin.

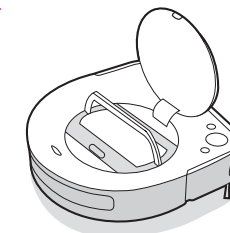

- 3 Press the bin release button to empty bin.

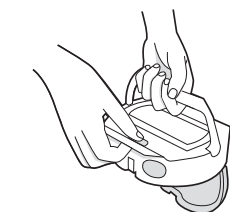

Cleaning the Filter

- 1 Open the filter door and remove the filter by grasping the tab.



- 2 Shake off debris by tapping the filter against your trash container.

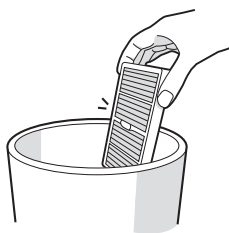

- 3 Reinsert the filter and close the filter door.

⚡ Important: The filter door won't close unless a filter is reinserted correctly. Replace the filter every two months.

Cleaning the Full Bin Sensors

- 1 Remove and empty the bin.
- 2 Wipe the inner sensors with a clean, dry cloth.

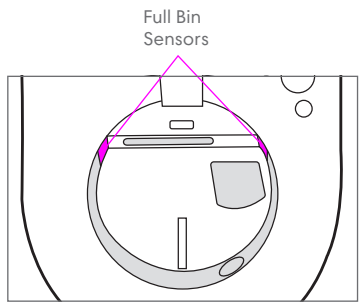

- 3 Remove the filter and wash the bin, or gently clean the bin to ensure the sensor ports are clean.

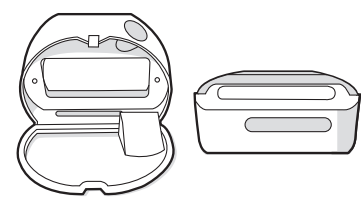

Washing the Bin

Important: Do not wash the filter. Remove the filter before washing the bin.

- 1 Release the bin, remove the filter, and open the bin door.
- 2 Rinse the bin using warm water.

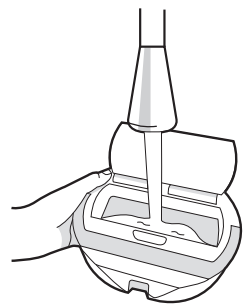

Note: Bin is not dishwasher safe.

- 3 Make sure bin is completely dry. Then reinsert filter and place bin back in the robot.

Cleaning the Corner Brush

- 1 Use a small screwdriver to loosen the screw holding the Corner Brush in place.
- 2 Pull to remove the Corner Brush. Remove any hair or debris, then reinstall the brush.

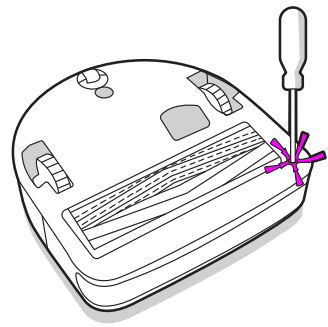

Cleaning the Rear Caster Wheel

- 1 Pull firmly on the rear caster wheel module to remove it from the robot.
- 2 Press firmly on the wheel to remove it from its housing (see illustration below).
- 3 Remove any debris from inside the wheel cavity.
- 4 Reinstall all parts when finished. Make sure the wheel clicks back into place.

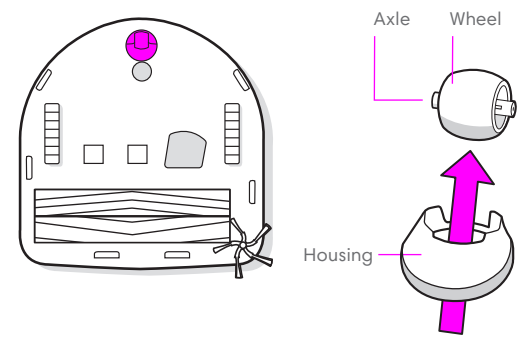

Important: A rear wheel clogged with hair and debris could result in damage to your floor. If the wheel is not spinning freely after you have cleaned it, please contact Customer Care.

Cleaning the Multi-Surface Brushes

- 1 Pinch the brush frame release tab, lift the brush frame, and remove any obstructions.
- 2 Remove the brushes from the robot. Remove the brush caps from the ends of the brushes. Remove any hair or debris that has collected beneath the caps. Reinstall the brush caps.
- 3 Remove any hair or debris from the square and star pegs on the opposite side of the brushes.
- 4 Remove the bin from the robot and clear any debris from the vacuum path.
- 5 Reinstall the brushes in the robot. Match the shape of the brush pegs with the shape of the brush icons in the cleaning head module.

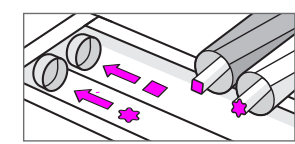
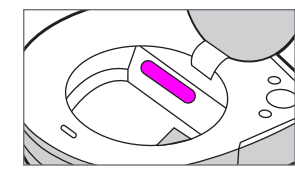
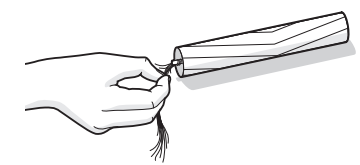
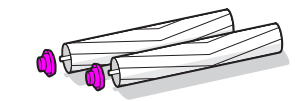
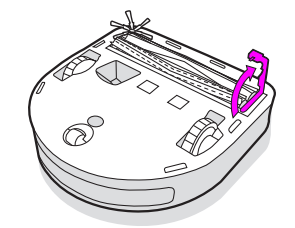

Cleaning the Sensors and Charging Contacts

- 1 Wipe sensors, camera window and charging contacts with a clean, dry cloth.

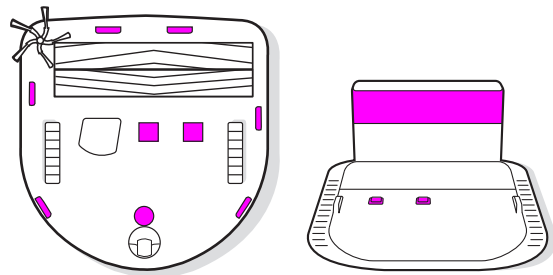
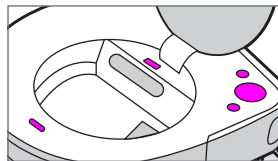

*** Important:** Do not spray cleaning solution or water onto the sensors or sensor openings.

iRobot Customer Care

USA & Canada

If you have questions or comments about your Roomba® robot vacuum or Clean Base™ Automatic Dirt Disposal, please contact iRobot before contacting a retailer.

You can start by visiting www.irobot.com for support tips, frequently asked questions and information about accessories. This information can also be found in the iRobot HOME App. If you need further assistance, call our Customer Care team at **(877) 855-8593**.

iRobot USA Customer Care Hours

- Monday to Friday, 9AM – 9PM Eastern Time
- Saturday and Sunday 9AM – 6PM Eastern Time

Outside USA & Canada

Visit global.irobot.com to:

- Learn more about iRobot in your country
- Get hints and tips to improve your Roomba® robot vacuum's performance
- Get answers to questions
- Contact your local support center

Regulatory Information

This device complies with part 15 of the FCC Rules.

Operation is subject to the following two conditions:

- (1) This device may not cause harmful interference, and
- (2) this device must accept any interference received, including interference that may cause undesired operation.

This device complies with Industry Canada license-exempt RSS standard(s). Operation is subject to the following two conditions:

- 1) This device may not cause interference, and
- 2) this device must accept any interference, including interference that may cause undesired operation of the device.

- Changes or modifications not expressly approved by iRobot Corporation could void the user's authority to operate the equipment.
- This equipment has been tested and found to comply with the limits for a Class B digital device, pursuant to part 15 of the FCC Rules as well as ICES-003 Rules. These limits are designed to provide reasonable protection against harmful interference in a residential installation. This equipment generates, uses and can radiate radio frequency energy and, if not installed and used in accordance with the instructions, may cause harmful interference to radio communications. However, there is no guarantee that interference to radio communication will not occur in a particular installation. If this equipment does cause harmful interference to radio or television reception, which can be determined by turning the equipment off and on, the user is encouraged to try to correct the interference by one or more of the following measures:

- Reorient or relocate the receiving antenna.
- Increase the separation between the equipment and receiver.
- Connect the equipment into an outlet on a circuit different from that to which the receiver is connected.
- Consult the dealer or an experienced radio/TV technician for help.
- Under Industry Canada regulations, this radio transmitter may only operate using an antenna of a type and maximum (or lesser) gain approved for the transmitter by Industry Canada. To reduce potential radio interference to other users, the antenna type and its gain should be so chosen that the equivalent isotropically radiated power (e.i.r.p.) is not more than the necessary for successful communication.
- FCC Radiation Exposure Statement: This product complies with FCC §2.1093(b) for portable RF exposure limits, set forth for an uncontrolled environment and is safe for the intended operation as described in this manual.
- ISED Radiation Exposure Statement: This product complies with the Canadian Standard RSS-102 for portable RF exposure limits, set forth for an uncontrolled environment and is safe for the intended operation as described in this manual.

For battery recycling go to call2recycle.org; or call 1-800-822-8837



©2019 iRobot Corporation, 8 Crosby Drive, Bedford, MA 01730 USA. All rights reserved. iRobot, Roomba, iAdapt and Virtual Wall are registered trademarks of iRobot Corporation. Clean Base and Dirt Detect are trademarks of iRobot Corporation. Wi-Fi and the Wi-Fi logo are registered trademarks of Wi-Fi Alliance.