

HOBOT-388

Exclusive Patent

WINDOW CLEANING ROBOT

User Manual



◎ Important Safety Precautions

Please read all instructions before using.

- Follow all instructions and warnings.
- After reading this manual, please keep it in an easily accessible location.
- Clear electrical cords, body parts and curtains away when using the device.
- Keep the device and accessories away from children.
- Keep the device in dry and cool place, away from direct sunlight, naked flames, heat, humidity, water and any other liquids.
- Do not store the device near oil, combustible spray or flammable materials.
- Product operating temperatures: 0°C ~40°C (32°F ~104°F)
- Product storage temperatures: -10°C ~50°C (14°F ~122°F)
- Prohibit children from using the device.

◎ Cautions

- Fasten the safety rope and tie to an indoor fixture before using the device.
- Check if the safety rope is broken or the knot is loose before using the device.
- The HOBOT window cleaning robots must be connected to a power outlet to operate.
- For windows with no balcony, a warning area must be established on the ground below to prevent people from coming near it.
- The UPS battery must be fully charged (green light ON) before using.
- Do not use on rainy or humid days.
- Turn power on before putting device onto the glass.
- When placing the device onto the glass, make sure it sticks to the surface before releasing the supporting hand.
- Remove the device before turning the power off.
- Do not use on frameless glass.
- Make sure to put the cleaning ring onto the cleaning wheel correctly to avoid air leakage.
- Remove any obstructions on the glass. Do not use on cracked glass.
- Reflective or coated glass may be scratched during operation by the dirt on the glass.
- Only fill the water tank with water or HOBOT window detergent, other detergents are not allowed.
- Empty the water tank before putting the device away.
- Please do not touch the ultrasonic spray nozzle.

© Safety Warnings

- Connect the power adapter only to a power source that matches the specifications. The power adapter is designed for connection to hazardous electrical voltages. Do not attempt to repair the adapter. Replace the whole unit if it is damaged or exposed to high moisture. Consult local HOBOT dealer for help and maintenance.
- Make sure the device, power adapter and power cord are not trapped under heavy objects.
- Allow adequate ventilation around the device and power adapter. Do not cover them with objects.
- Do not use the device and adapter in a strong magnetic field, humid or high heat environment.
- This device has non-removable battery.
- Please use the original power adapter and power cord that came with the device. Use any third-party components may result in damage, malfunction and/or danger.
- Battery can explode, catch fire, and/or cause burns if disassembled, crushed, cut, punctured, short-circuited, incinerated, recharged (disposable cells), or exposed to water, fire, or temperatures above 60°C (140°F).
- If the device is not in use for a long period of time, store it in a dry and safe location. The battery will need to be charged every 3 months to maintain battery life.
- Never operate this device if the cord or power adapter is damaged. Ensure the power cord is not stretched or exposed to sharp object or edges.
- Do not use the device if any part or any accessory is damaged or defective.
- Switch off the power and disconnect the power plug before dismantling, assembling or cleaning the device and power adapter.
- Do not clean the unit by spraying it or immersing it in water. The device is not waterproof.
- Any service other than regular cleaning should be only performed by an authorized service representative.
- Contact your local waste management authority to follow local disposal regulations and never dispose the device and rechargeable batteries with normal household waste.

© Copyright & Trademarks

Copyright© 2019 by HOBOT® Technology Inc. All rights reserved.

No part of this publication may be reproduced, transmitted, transcribed, stored in a retrieval system or translated into any language or computer language, in any form

or by any means, electronic, mechanical, magnetic, optical, chemical, manual or otherwise, without the prior written permission of this company.

All other logos, products, or company names mentioned in this manual may be the registered trademarks or copyrights of their respective companies, and are used for informational purposes only.

©Disclaimer

HOBOT Technology Inc. makes no claims or warranties, either expressed or implied, with respect to the contents hereof and specifically disclaims any warranties, tradability or suitability for any particular purpose. Furthermore, HOBOT Technology Inc. reserves the right to revise this publication and to make changes from time to time in the contents hereof without obligation of this company to provide notification of such revisions or changes. The user should follow the instructions provided in this user manual, but is ultimately responsible for assessing placement and safety when using this cleaning tool.

©Limited Warranty

If there are defects in your HOBOT due to faulty materials, poor workmanship, or malfunction within the warranty period from the date of purchase or delivery, please immediately contact a local retailer or local authorized dealer for repairs or replacement. This limited warranty does not cover:

- Normal wear and tear, including parts that might wear out over time (e.g. water tank, spraying nozzle, cleaning cloth, safety rope and packaging, etc.)
- Reduction in battery runtime due to battery age or use, as the life of the battery (1 year) and number of times the device is used.
- Transit, delivery or accidental damage or misuse and abuse that is not in accordance with the instructions.
- Faults or damage caused by:
 - Negligent use, misuse, abuse or careless operation of the device.
 - Use of the device which is not in accordance with this manual.
 - Use of anything other than normal domestic household purposes in the country in which it was purchased.
 - Use of parts not assembled or installed in accordance with this instruction.
 - Use of any unauthorized parts and accessories. Please contact a local retailer or local authorized dealer for spares and accessories.
 - Faulty assembly or installation.
 - Repairs or alterations carried out by parties other than HOBOT authorized dealer.

◎Product Description

HOBOT-388 is a glass-cleaning robot with a vacuum motor inside that generates strong suction power to allow it to stay attached to the glass. The new patented invention carries a detachable water tank along with an ultrasonic spray nozzle which nebulizes water to mists then sprays it evenly on glass simulating the effect of human breath on the glass. HOBOT-388 has two specially-design cleaning wheels that can freely move on the glass, and even walls. The screw-in DC power jack design can avoid losing power during usage, while the embedded UPS (Uninterrupted Power System) can prevent the robot from falling off the window for 20 minutes even in case lost power; ultimately, the safety rope can endure the impact force up to 200kg to catch any fall. The reusable lint-free Microfiber cloth is used on both cleaning wheels to attain superior glass cleaning. HOBOT has AI Technology that can calculate paths, auto-detect window edges, and auto-clean entire window. Beside equipped remote control, HOBOT-388 can be controlled by iOS and Android devices via blue tooth connection.

◎Product Features

- Designed for glass in any thickness
- AI Technology V4.0
- Ultrasonic water spray
- Cleaning speed: 4 min/m²
- 3 automatic operation modes for cleaning the entire window
- Stops automatically upon completion of cleaning
- Embedded UPS (Uninterrupted Power System)
- Anti-falling control algorithm
- High sensitivity pressure sensor
- Auto-detects edges of window
- Extra secure DC power connector
- Microfiber cleaning cloth
- Remote/App control

◎Product and Accessories

Device × 1

Adapter × 1

AC power cord × 1

DC extension cord × 1

Remote control × 1

Cleaning rings × 4

Window detergent × 1

Microfiber cleaning cloth × 14

Safety rope × 1

Ultrasonic nozzle × 1

User manual × 1

©About HOBOT-388

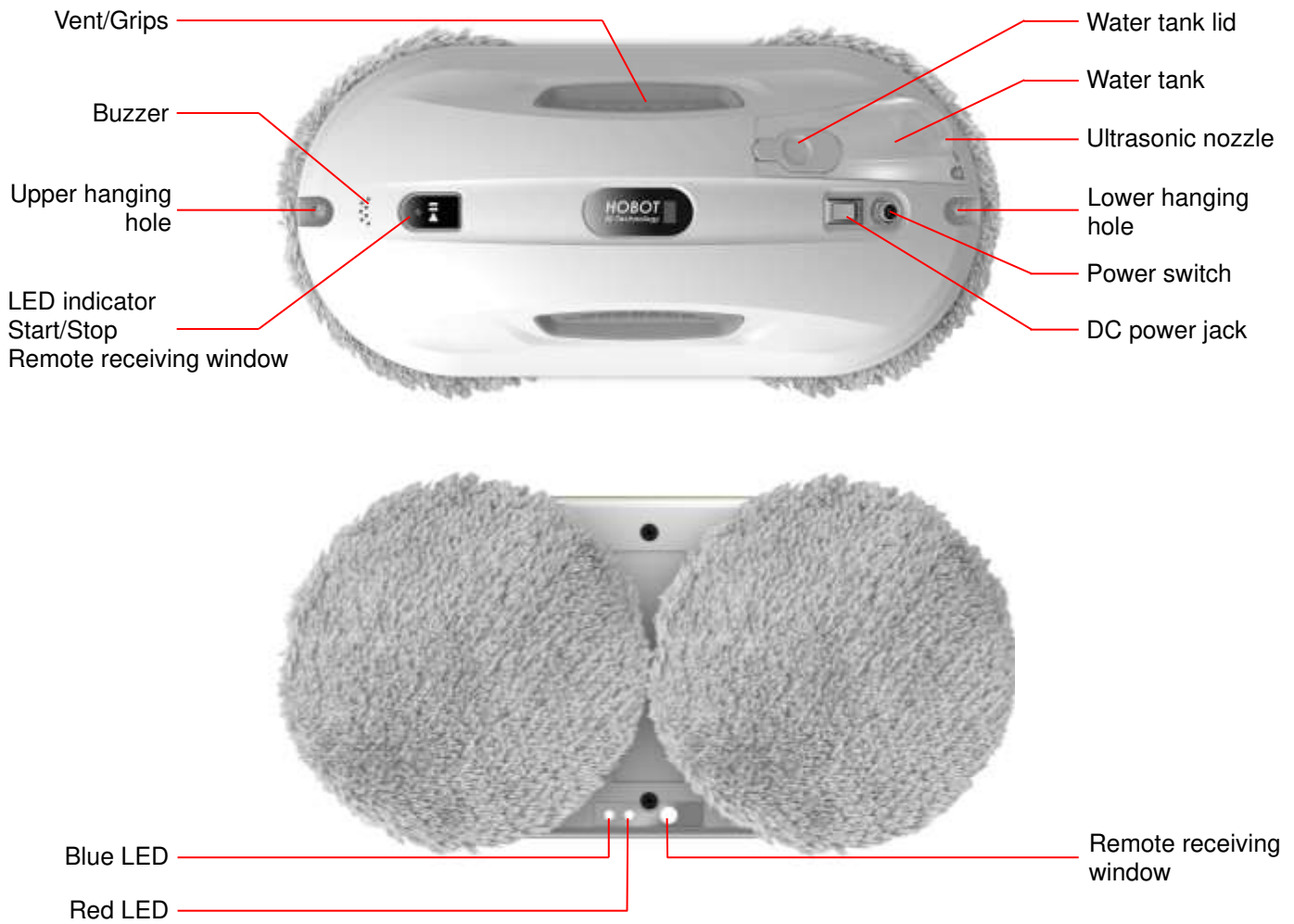

©How to Clean the Glass

1. "Dry Clean" first

- Turn off the water spray and put on a pair of clean and dry cleaning cloth to wipe dust and dirt off the glass.
- If there is water or detergent on the cloth or glass, the muddy mixture of the moisture, dust and dirt will make the cleaning results bad.
- Please use HOBOT on sunny days or days with low humidity for best results.
- Don't use HOBOT on rainy or high humidity days to avoid leaving water molecules streaks.



2. "Wet Clean" later

Use another pair of clean and dry cleaning cloth, spray small amount of detergent or water on the lower cleaning cloth while keeping the upper cleaning cloth dry then clean the glass again.

◎ Instructions

1. Setup

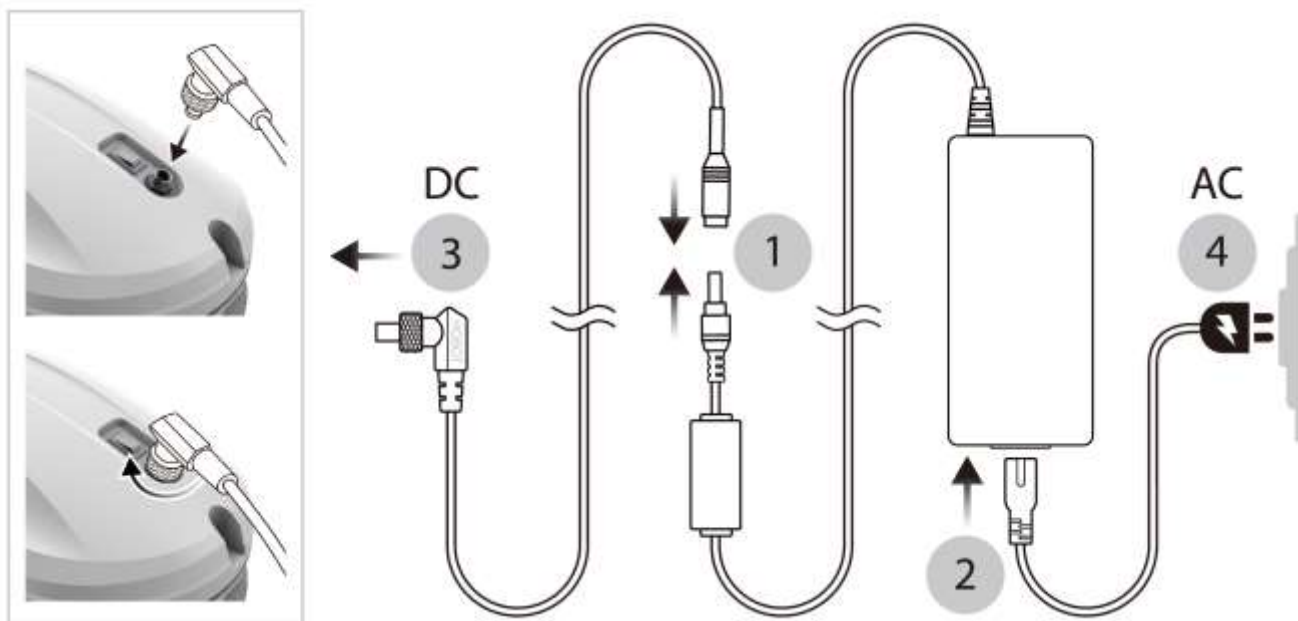

- (1) Connect the adaptor to DC power cord.
- (2) Connect the adaptor to AC power cord.
- (3) Plug L-shape connector into DC power jack on HOBOT and screw tight the L-shape connector.
- (4) Plug AC power cord into the socket.

2. Charging the Battery

Make sure the battery is fully charged (green light ON) before use:

- (1) Turn off the power switch on HOBOT and then plug it into a power source. Orange light ON means charging.
- (2) Green light ON means the battery is fully charged.

3. Install Cleaning Cloth and Cleaning Ring

Make sure the cleaning ring is perfectly covered by the cleaning cloth and attach the cleaning ring to the cleaning wheel correctly to avoid air leakage.

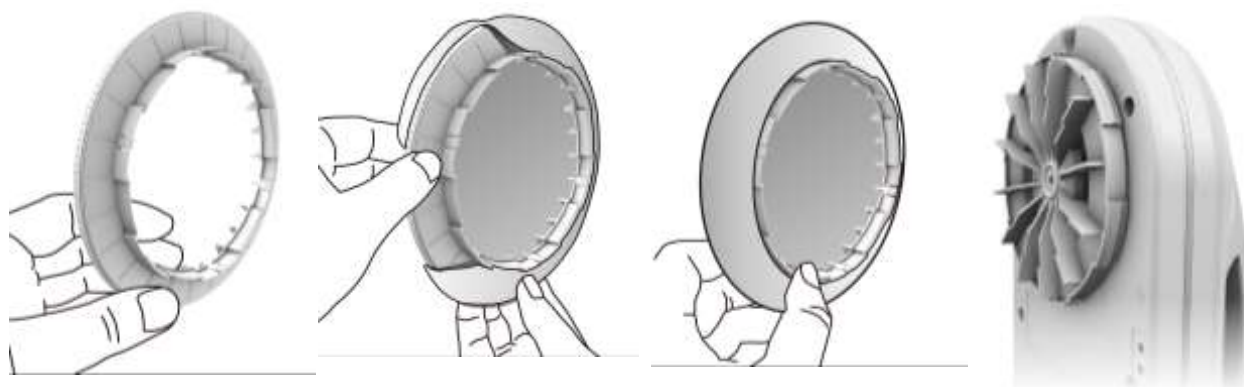

4. Safety procedures

- (1) For windows with no balcony, a warning area must be established on the ground below to prevent people from coming near it.
- (2) Please check if the safety rope is broken or the knot is loose.
- (3) Fasten the safety rope and tie to an indoor fixture before using HOBOT.

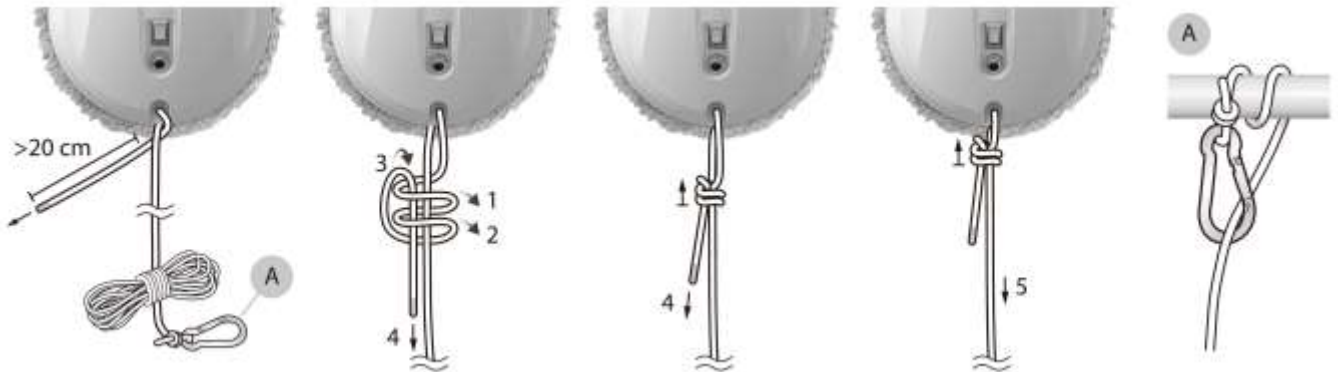

5. Fill the Water Tank

Fill the water tank only with pure water or HOBOT window detergent to the “MAX” line and tighten the tank lid fully.



6. Put HOBOT onto the glass

- (1) Turn power switch on. Make sure fan is running.
- (2) Put HOBOT onto the glass and keep 10cm away from the edge.
- (3) Check if HOBOT is sticking to the glass before releasing it.

7. Cleaning with Auto Mode and Manual Mode

- (1) Press or or , HOBOT will automatically clean the entire window.
- (2) Press or to stop HOBOT.
- (3) Press to manually control the HOBOT's moving direction.

8. Finish and Remove HOBOT from Glass

- (1) Hold the safety rope with one hand and grasp HOBOT tightly with the other hand to remove HOBOT off the glass.
- (2) Switch off HOBOT in a safe area.

◎UPS (Uninterrupted Power System)

- (1) The UPS supplies power during power outage. The backup time of the UPS is 20 mins.
- (2) HOBOT will stop automatically, play alert, and flash red and blue light. Please take down HOBOT from the glass as soon as possible.
- (3) The safety rope can be used to pull HOBOT back. Gently pull the safety rope at an angle close to the glass to avoid it from falling.

◎Cleaning & Maintainance

1. Cleaning Cloth Care Instructions

- Washing under 40°C (104°F).
- Do not bleach.
- Do not use softener.
- Do not tumble-dry.
- Do not iron.
- Do not dry clean.

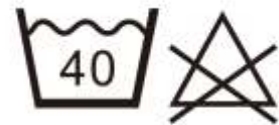

Care Frequency: After each use.

Please contact a local retailer or local authorized dealer for additional consumable spare parts.

2. Replace the water tank

- (1) Use a Philips screwdriver to uncrew the water tank.
- (2) Disconnect the cable from the old water tank and then slide out the water tank.
- (3) Connect the new water tank to HOBOT and slide the tank back, then fasten the screw.

Care Frequency: When ultrasonic nozzle is clogged and cannot spray water.

Please contact a local retailer or local authorized dealer for additional consumable spare parts.



3. Replace the ultrasonic spray nozzle

- (1) Follow above instructions to disattach the water tank.
- (2) Lightly lift up the silicone ring and apart it from the water tank. Don't press the welding spot and/or ultrasonic nozzle.
- (3) Place the new ultrasonic spray nozzle on the water tank, make sure the connecting cable is aligned to near the side of the water tank, then fit



the bottom of the silicone ring to the water tank.

(4) Press the silicone ring to secure it, then use another finger push the top of silicone ring into the water tank lightly.

(5) Please check if the new ultrasonic spray nozzle fits the water tank tightly.







(6) Connect the new water tank to HOBOT and slide the tank back, then fasten the screw.



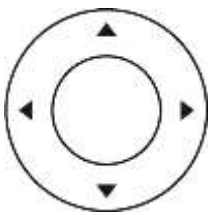

Care Frequency: When ultrasonic nozzle is clogged and cannot spray water.
Please contact a local retailer or local authorized dealer for additional consumable spare parts.

◎ Remote Control and App Control

HOBOT can be remote controlled from the front and back sides.

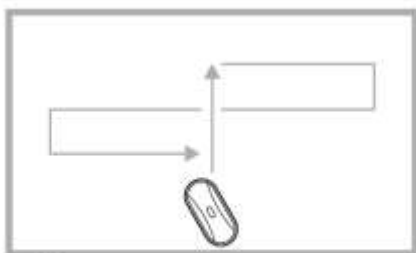
	Spray Water: on/off
	Spray Once
	Auto Cleaning: up then down
	Auto Cleaning: left then down
	Auto Cleaning: right then down
	Manually Control
	Stop Cleaning
	Clean Twice



 Auto Cleaning: up then down

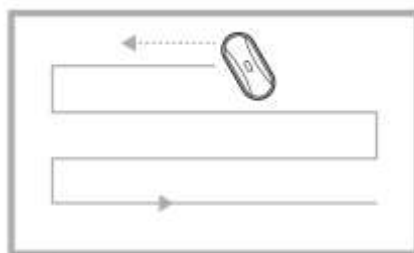

 Auto Cleaning: left then down

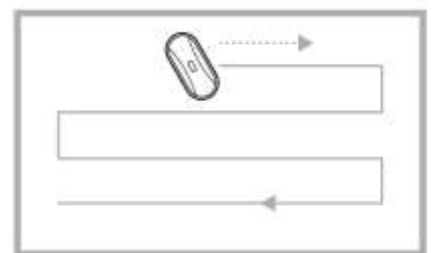

 Auto Cleaning: right then down

◎ App Instructions

HOBOT-388 can be controlled by both the equipped remote control and HOBOT App via Bluetooth.

1. Download and Install HOBOT App

Scan QR code or search “HOBOT” on the App Store or Google Play to download HOBOT app on your smartphone or tablet.



2. Start Cleaning with HOBOT App

- (1) Turn on Bluetooth and tap open HOBOT App.
- (2) Turn on HOBOT and wait for “Connected” shown on HOBOT App.

◎ LED Indication



Status	LED indication	Alert	Situation and handling
Charging	Orange light on	none	UPS charging.
	Green light on	none	UPS fully charged.
Operating	White and blue light flashing	none	Low UPS battery, please refer to FAQ Q1 to resolve.
	Blue light on	none	Cleaning with water spray.
	White light on	none	Cleaning without water spray.
	White light flash once	none	Spraying water.
	Blue/White light on	One long and two short beeps	Cleaning completed.
	Light is off	One beep	Air leakage, HOBOT will reverse.
	Red and blue light flashing	Continuous alert	Power disrupted, please reconnect to the power source. In case there's power outage or unable to re-establish the power source, please refer to FAQ Q2 to resolve.
	Blue light flashing	Two beeps	Please refer to FAQ Q3 to resolve.
	White light flashing	Two beeps	Please refer to FAQ Q7 and Q8 to resolve.
	Red light flashing	Two beeps	Hardware failure. Please contact a local retailer or an authorized dealer for repairs.



◎ Frequently Asked Questions (FAQ)



1. Charging UPS battery.

If HOBOT is not in use for a long period of time, store it in a dry and safe location. The battery will need to be charged every 4 to 6 months to maintain battery life. If the battery can not be fully charged after 3 to 4 hours, please contact a local retailer or an authorized dealer for battery replacement.

2. **HOBOT stops working due to power outage with long alert and red, blue light flashing.**
 - (1) Hold the safety rope with one hand and grasp HOBOT tightly with the other hand to remove HOBOT off the glass.
 - (2) Switch off HOBOT in a safe area.
 - (3) Check if the power cord is damaged or broken.
3. **Blue light flashing with beeping sound when HOBOT fails on completing the initiation check.**
 - (1) Whether the cleaning cloth is too dirty.
 - (2) Glass stickers and window film have a friction factor that is too low.
 - (3) If the window is cleaned many times, the glass will become very slippery.
 - (4) The glass will become slippery if cleaned several times in a low humidity environment such as in a air-conditioned room.
 - (5) Please keep it 10 cm or more away from the window frame when placing HOBOT to avoid false detection.
4. **HOBOT slips and cannot detect the upper frame of window in “Auto Up then Down ” mode.**

Press  and switch to  or  auto cleaning mode.
5. **HOBOT slips and can't move upward to the top of the window.**
 - (1) The friction factor is too low, usually caused by the glass stickers or window film on the glass.
 - (2) The cleaning cloth might be too wet.
 - (3) If the window has been cleaned many times, the glass surface will become very slippery.
 - (4) The glass surface will become slippery if cleaned several times in a low humidity environment such as in an air-conditioned room.
 - (5) Please keep it 10 cm or more away from the window frame when placing HOBOT to avoid false detection.
6. **HOBOT cannot finish cleaning the whole window and stops during the middle of the work.**

Press  or  switch to left or right auto cleaning mode.
7. **Blue light flashing with beeping sound when HOBOT stops at the edge of the glass.**

Some glass sealing strips are very flat that HOBOT sometimes can ride/stuck on them and cause air leakage, please move HOBOT to 10 cm or more away from the window frame and use  or  auto cleaning mode to continue.

8. HOBOT does not move smoothly, or it moves irregularly.

- (1) Cleaning cloth is too dirty, please replace it.
- (2) The friction factor difference due to glass stickers, window film, etc. Please avoid using HOBOT on the glass with special finish.
- (3) The screw of the cleaning wheel might have become loose. Just tighten it.
- (4) The cleaning ring is broken, please replace it.

9. After cleaning, swirl marks are left on the glass.

Cleaning cloth is too dirty or too wet, please replace it.

10. How to avoid leaving swirl marks on the glass which is visible under strong light?

Use a pair of clean and dry cleaning cloth to wipe dust and dirt off the glass, then use another pair of clean and dry cleaning cloth, spray small amount of detergent or water only on the lower cleaning cloth while keeping the upper cleaning cloth dry and clean the glass again.

11. HOBOT does not stop cleaning after completing the task.

Please press  button to stop HOBOT.

12. Unable to link to App/HOBOT

- (1) Please restart HOBOT and App.
- (2) Please turn on Bluetooth function on your smartphone and connect.
- (3) Please check the Bluetooth device list on your smartphone and select "HOBOT".

13. HOBOT does not spray water.

- (1) Check if you have turned on the spraying function.
- (2) Clean the ultrasonic nozzle with a soft, dry and clean cloth.
- (3) Replace the water tank after tried (1) and (2).

If any problems occur and this manual cannot provide the solution you need, please contact a local retailer or local authorized dealer.

© Specifications

Model	HOBOT-388
Adhesive type and shape	Vacuum, Round
Weight	915 g
Device size (LWH)	295×148×95 mm (11.6×5.8×3.7 in)
Software	AI Technology V4.0
Cleaning method	Rotating, Zigzag
Auto water spray	●
Replaceable water tank	●
Suitable glass thickness	All thickness

Input voltage	100-240V, 50/60Hz
Power consumption	90W
Un-interrupt Power System (UPS)	20mins
Certifications	CE, FCC, RoHS

HOBOT

Cleaning Revolution

